

Mathematische Morphologie

- Binäre Morphologie
 - Strukturelement
 - Grundlegende Operatoren
 - Erosion, Dilation
 - Abgeleitete Operatoren
 - Open, close
- Grauwert-Morphologie

Foliensatz W. Burger, W. Backfrieder

Backfrieder-Hagenberg

Ziel: Segmentierung eines DNA-Chips

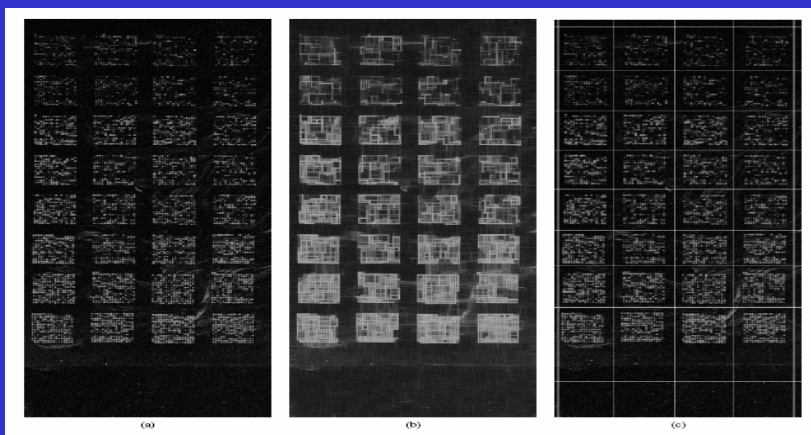

(a) natives Array, (b) morphologisch gefiltert, (c) in Sektoren eingeteilt [J. Angulo, J. Serra, 2003].

Backfrieder-Hagenberg

Binärbilder

nur 2 Pixelwerte:

BLACK	WHITE
0	1 (255)

Binarisierung durch

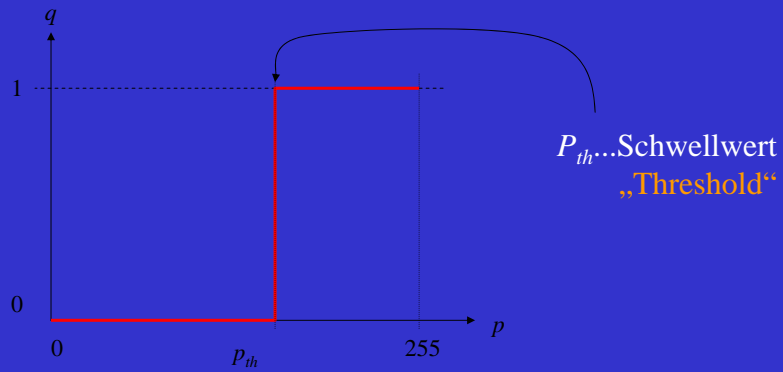

Backfrieder-Hagenberg

Original

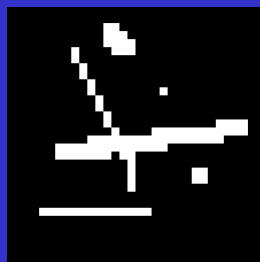

gefiltert

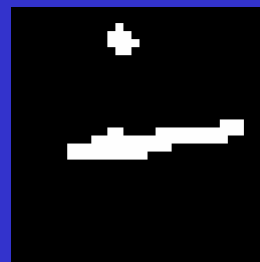

- dünne Elemente werden eliminiert
- dicke Elemente bleiben erhalten

Ergebnis ist abhängig von lokaler Bildstruktur!

Backfrieder-Hagenberg

Kann man Filter bauen, die auf **bestimmte Strukturen** gezielt reagieren?

Bsp.: kleine Flecken eliminieren

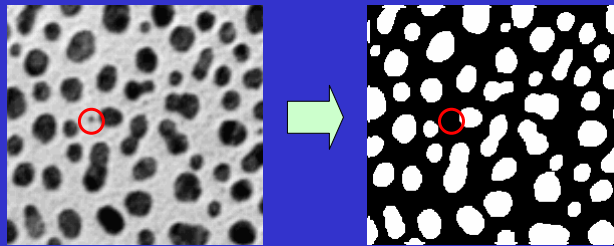

Backfrieder-Hagenberg

1. alle Regionen "schrumpfen" (kleine verschwinden)

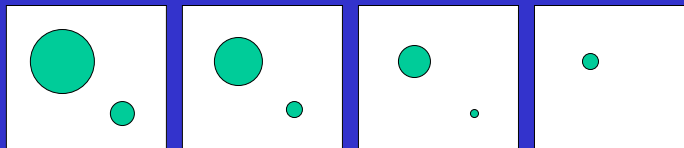

2. übrige Regionen wieder **wachsen** lassen

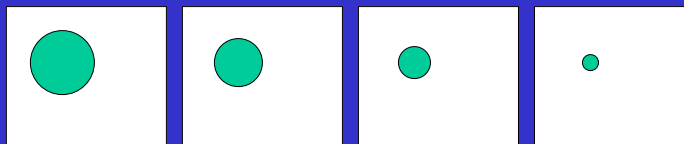

Backfrieder-Hagenberg

"Schrumpfen" einer Region (1)

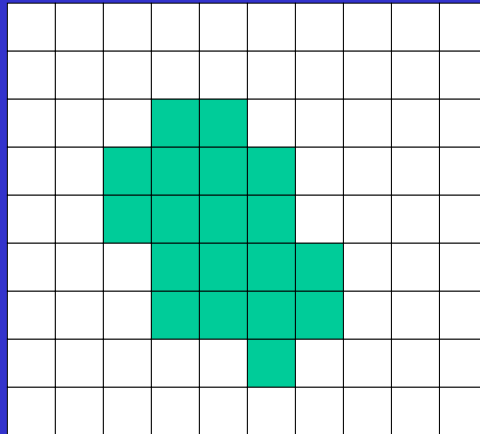

Original

Backfrieder-Hagenberg

"Schrumpfen" einer Region (2)

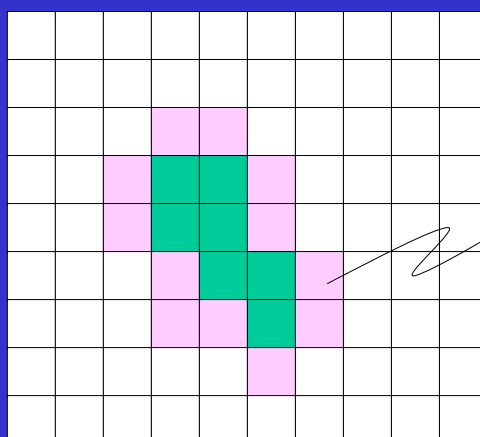

Abschälen
einer Schicht

"Erosion"

Backfrieder-Hagenberg

"Schrumpfen" einer Region (3)

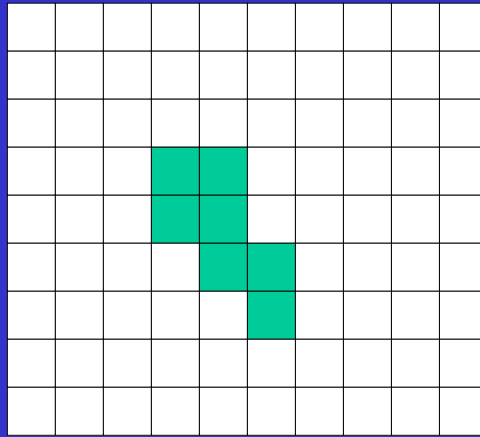

Ergebnis

"Erosion"

Backfrieder-Hagenberg

Bsp. "Erosion"

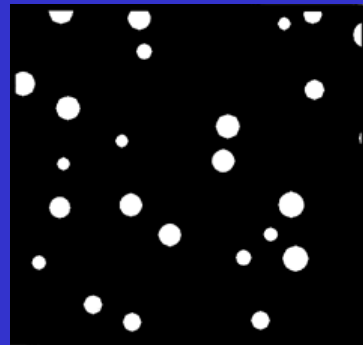
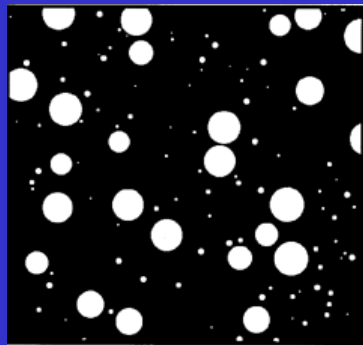

[Weeks]

Backfrieder-Hagenberg

Wachsen" einer Region (1)

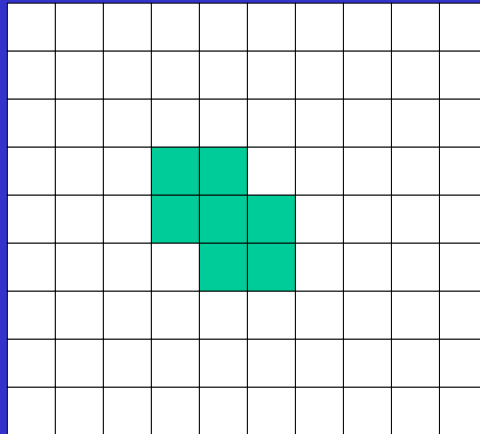

Original

Backfrieder-Hagenberg

"Wachsen" einer Region (2)

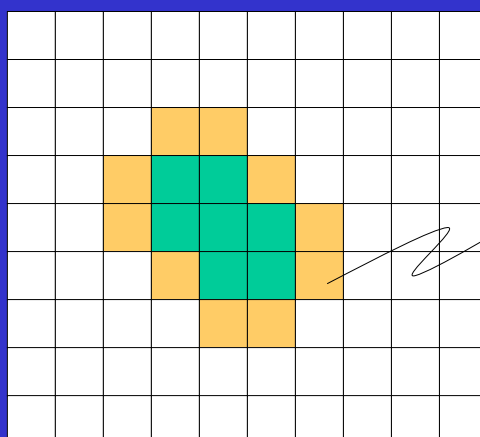

Hinzufügen
einer Schicht

"Dilation"

Backfrieder-Hagenberg

"Wachsen" einer Region (3)

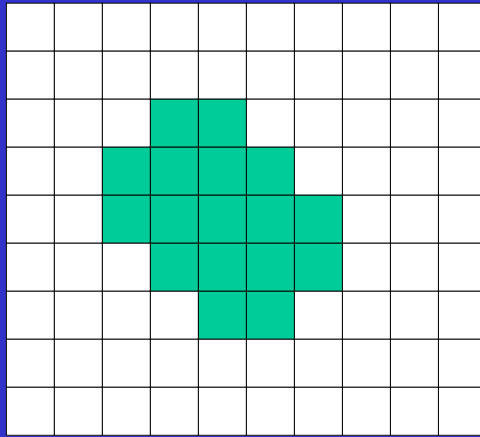

Ergebnis

"Dilation"

Backfriedler-Hagenberg

Bsp. "Dilation"



[Weeks]

Backfriedler-Hagenberg

- EROSION, DILATION: wie definiert?
- Gibt es weitere solche Operationen?



Morphologische Filter

Strukturelement
(analog zur
Impulsantwort):

H =

		•	
•	•	•	
		•	

„Hot Spot“

Backfriedler-Hagenberg

Darstellung als Mengen:

Bsp.:

	0	1	2	3
0				
1		•	•	
2			•	
3				

$$A = \{(1,1), (2,1), (2,2)\}$$

(Bild)

(x_a, y_a)

	-1	0	1
-1			
0		•	•
1			

$$H = \{(0,0), (1,0)\}$$

(Strukturelement)

Backfriedler-Hagenberg

Dilation

$$B = A \oplus H$$

$$A \oplus H = \{(x,y) \mid (x,y) = (x_a,y_a) + (x_h,y_h)\}$$

für alle möglichen Paare
 $(x_a,y_a) \in A, (x_h,y_h) \in H$

Backfrieder-Hagenberg

Bsp.: Dilation $A \oplus H$

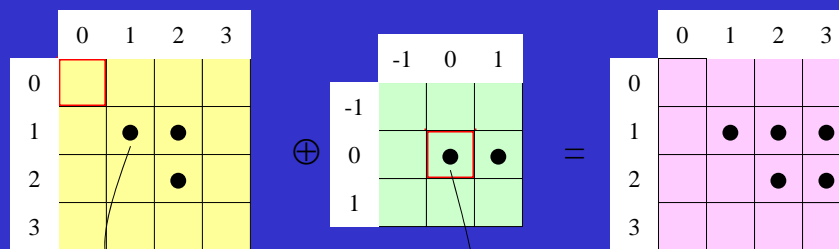

$$A \oplus H = \{ (1,1)+(0,0), (1,1)+(1,0), (2,1)+(0,0), (2,1)+(1,0), (2,2)+(0,0), (2,2)+(1,0) \}$$

Backfrieder-Hagenberg

Bsp.: Dilation $A \oplus H = B$

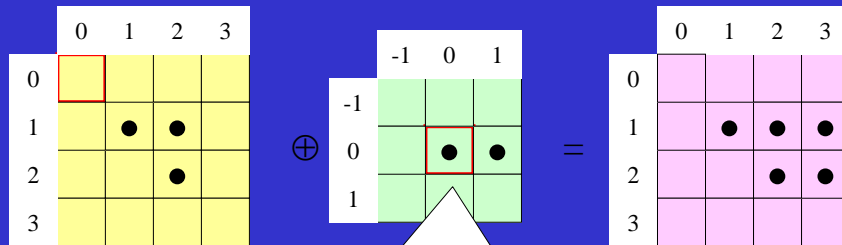

Wenn am Hotspot das Element in A gesetzt ist, dann werden in B alle Elemente von H markiert!

Backfrieder-Hagenberg

Erosion $A \ominus H = B$

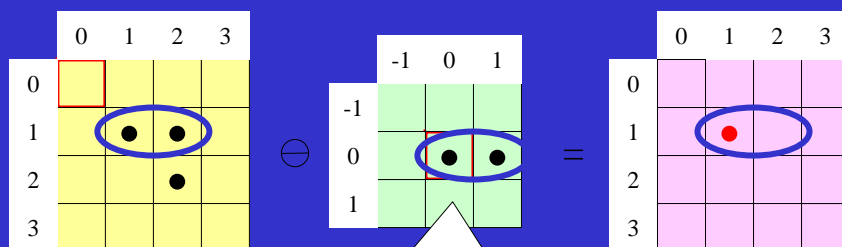

Wenn alle Elemente von H in A Überlappung finden, nur dann wird in B der Hot-Spot markiert!

Backfrieder-Hagenberg

Erosion

$$B = A \ominus H$$

$$A \ominus H = \{(x,y) \mid (x,y) + (x_h,y_h) \in A\}$$

für alle möglichen Punkte
 $(x_h,y_h) \in H$

Backfrieder-Hagenberg

Bsp.: Erosion $A \ominus H = B$

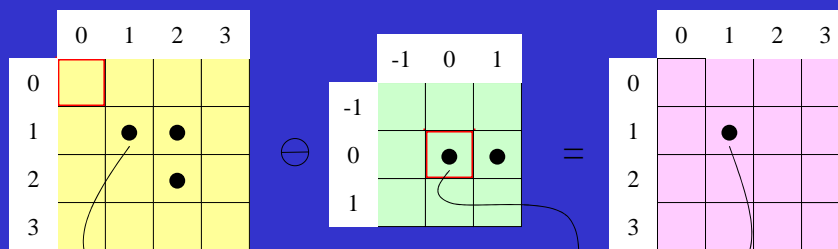

$$A \ominus H = \{(1,1)\}$$

weil $(1,1) + (0,0) = (1,1) \in A$
und $(1,1) + (1,0) = (2,1) \in A$

Backfrieder-Hagenberg

Dilation

$$A \oplus H = H \oplus A \text{ kommutativ}$$

$$(A \oplus B) \oplus C = A \oplus (B \oplus C) \text{ Kettenregel (assoziativ)}$$

Erosion

$$A \ominus H \neq H \ominus A \text{ NICHT kommutativ}$$

$$(A \ominus B) \ominus C = A \ominus (B \oplus C) \text{ Kettenregel}$$

Backfrieder-Hagenberg

Typische Strukturelemente

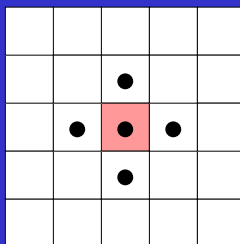

4-Neighborhood

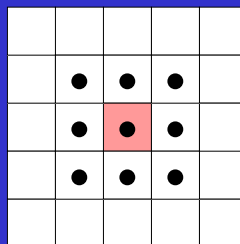

8-Neighborhood

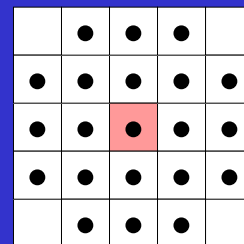

Small Disk

Backfrieder-Hagenberg

Paarweise Anwendung (Erosion + Dilation)

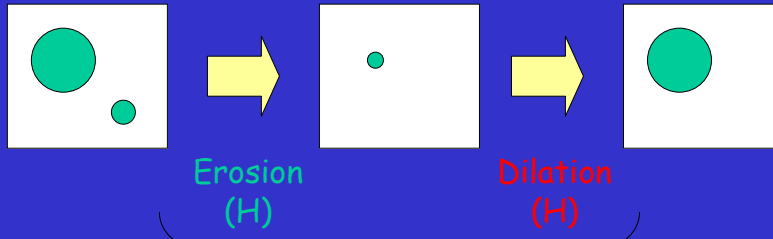

"Opening"

$$(A \ominus H) \oplus H = A \circ H$$

Kleine Strukturen werden eliminiert

Backfrieder-Hagenberg

Bsp. "Opening"

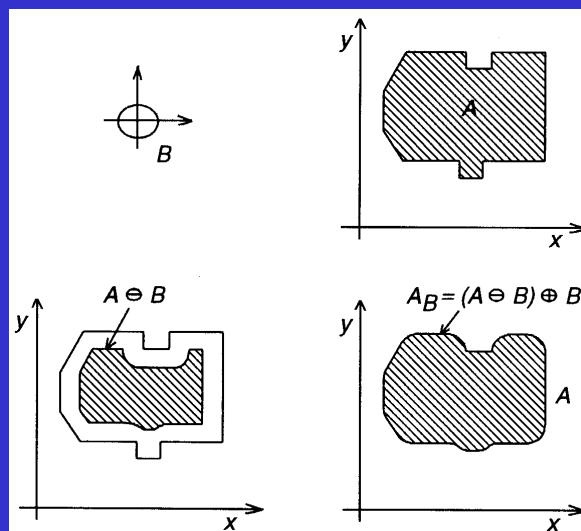

Backfrieder-Hagenberg

Bsp. "Opening"

$$(A \ominus H) \oplus H$$

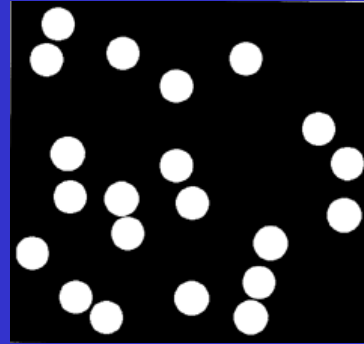
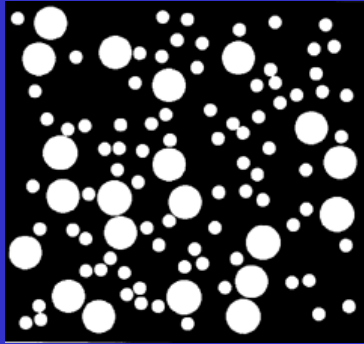

[Weeks]

Backfriedler-Hagenberg

Paarweise Anwendung (Dilation + Erosion)

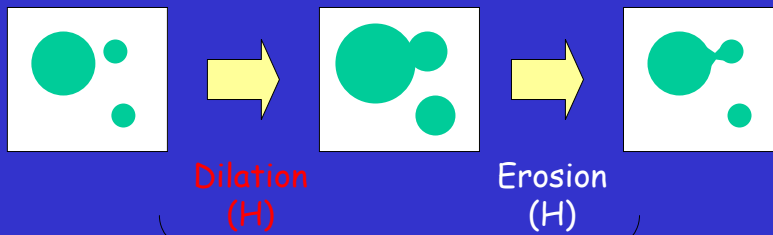

"Closing"

$$(A \oplus H) \ominus H = A \bullet H$$

Kleine Abstände werden geschlossen

Backfriedler-Hagenberg

Bsp. "Closing"

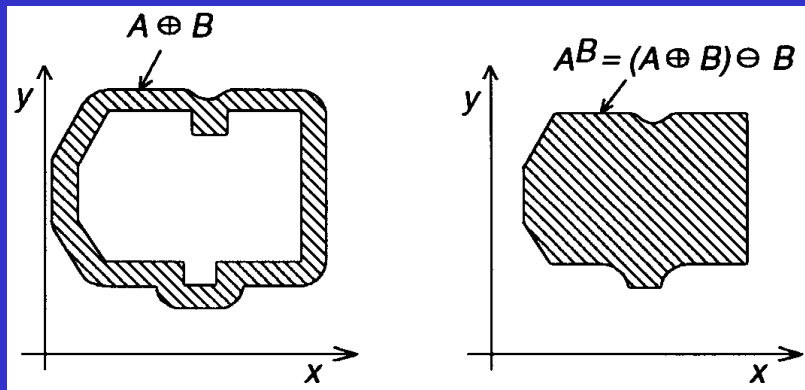

Backfrieder-Hagenberg

Bsp. "Closing"

$$(A \oplus H) \ominus H$$

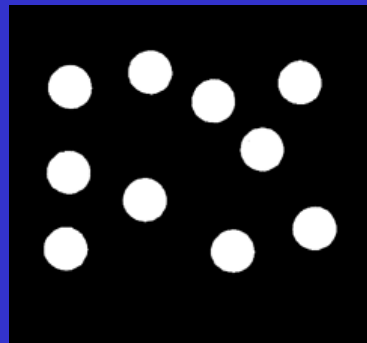
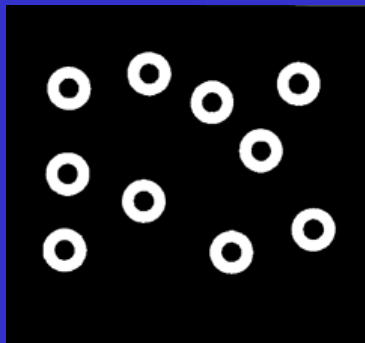

[Weeks]

Backfrieder-Hagenberg

Zusammenfassung:

- Morphologische Filter (MF) reagieren selektiv auf Bildstrukturen
- Erosion/Dilation sind grundlegende Operationen
- Opening/Closing = Hintereinanderausführen von Erosion/Dilation
- Eindeutige Spezifikation durch "Strukturelement"

Backfrieder-Hagenberg